

Flow switch for liquid media



flow-captor 412x.1xM 10.5 - 36 VDC

The flow-captor 412x.1xM 10.5 - 36 VDC is ideally suited for use in automation processes or other industrial applications where liquid media has to be monitored. The sensor works according to the calorimetric measuring principle, fully electronic and without any mechanically moved parts. The flow-captor detects the flow velocity of the medium and converts it into an electrical signal.

- **voltage range from 10.5 to 36 VDC**
- precise switching flow monitor
- high switching accuracy even with slower flows
- separate adjustment of Set-point and Range
- display of the flow condition and the switching point via LED chain
- LED for output status
- robust industrial design (special potting)
- **ISO 9001:2015**



Control and Display Panel

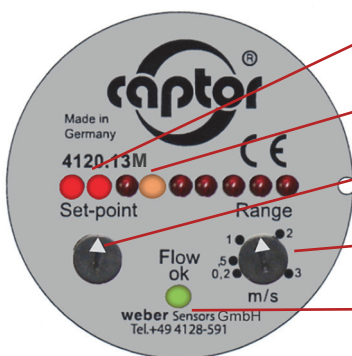

- LED-chain for display of flow range
- Flashing LED for display of adjusted set-point
- Potentiometer for flow set-point
- Potentiometer for adjustment of measuring range from .2 to 3 m/s
- LED for display of output status

Example of operation

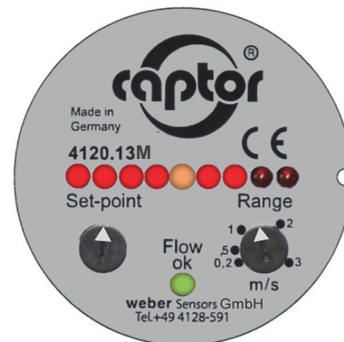

- Measuring range adjusted to 3 m/s = 100 % (9. LED)
- Set-point adjusted to 50 % of end value (5. LED)
- Flow speed equates 75 % (7. LED)
- Green LED is **ON**: Flow rate is above the adjusted set-point.

1/2" BSP thread standard size



The flow-captor 412x.1xM 10.5 - 36 VDC is available with different sensor head versions.

- 1/2" BSP thread – standard size –
- Extended sensor probes with 1/2" BSP thread are available
- NPT thread as option

Sensor heads

The sensor head is constructed of only one piece of electropolished stainless steel and without any sensor element intruding into the medium. Easy installation by means of T-piece or welded fitting.

For aggressive media special materials can be offered.

The electronics inside is completely epoxy resin encapsulated.

flow-captor 412x.1xMK 10.5 - 36 VDC

Cooling version with heat sink for medium temperature up to 130 °C

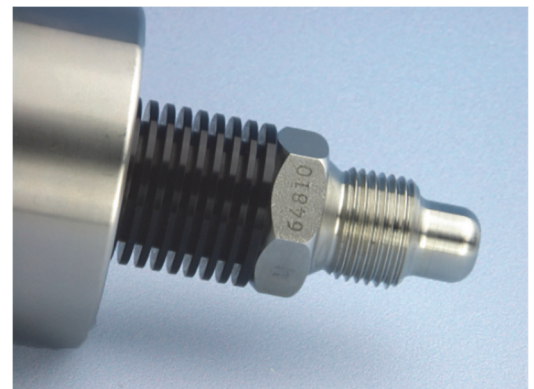

weber

Sensors GmbH Strohdreich 32
Sensors Ltd. 66 Eastbourne Road, Southport
Sensors LLC. 4462 Bretton Court, Building 1, Suite 7

DE-25377 Kollmar, Germany Tel.: +49 (0)4128 - 591 · Fax: - 593
Merseyside PR8 4DU, UK Tel.: +44 (1704) - 551684 · Fax: - 551297
Acworth, Georgia 30101, USA Tel.: +1 (770) 592 - 6630 · Fax: - 592 6640

www.captor.de
info@captor.de
sales@captor.co.uk
sales@captor.com

Flow switch for liquid media



flow-captor 412x.1xM 10.5 - 36 VDC

Technical data		
Type	4120.1xM 10.5 - 36 VDC	4121.1xM 10.5 - 36 VDC
Media	water-based	oil-based
Sensor data		
Measuring range	0 - 20 cm/s to 0 - 300 cm/s, continuously adjustable *1	0 - 30 cm/s to 0 - 300 cm/s, continuously adjustable *2
Set-point range	approx. 15 % - 90 % of range setting	approx. 15 % - 90 % of range setting
Medium temperature	-20 °C to +80 °C	
Ambient temperature	-20 °C to +70 °C	
Pressure	max. 100 bar (1450 PSI)	
Response time	2 sec. - 10 sec. depending on range setting	2 sec. - 15 sec. depending on range setting
Linearity deviation	< 5 % *1	< 5 % *2
Repeatability tolerance	< 2 %	
Hysteresis	approx. 10 %	
Temperature drift	< 0.3 % K	
Mechanical data		
Protection class	IP67	
Material of housing	stainless steel AISI 303	
Material of sensor probe	stainless steel AISI 303 (other material on request)	
Sensor probe sizes		a) flow-captor 412x.1xM 10.5 - 36 VDC / BSP Length 30 mm, 1/2" BSP
(A): Sensor head AISI 316		b) flow-captor 412x.1xMA 10.5 - 36 VDC / BSP S110/45 Length 45 mm, 1/2" BSP
(S110/xx): Length from hexagon bolt to sensor tip		c) flow-captor 412x.1xMA 10.5 - 36 VDC / BSP S110/67 Length 67 mm, 1/2" BSP
		d) flow-captor 412x.1xMA 10.5 - 36 VDC / BSP S110/90 Length 90 mm, 1/2" BSP
Electrical connection	4-pin M12-coupling	
Connection cable (optional)	PUR-cable type 4940, 3 x 0.34 mm ² with 4-pin M12 plug	
Electrical data		
Operating voltage	10.5 - 36 VDC, incl. residual ripple	
Current consumption	max. 150 mA (pulsed)	
Power consumption	approx. 1 W	
Switching current	≤ 400 mA	
Circuit protection	reverse polarity, short circuit and overload	
Voltage drop	< 2,5 V at max. load	
Ready to operate	approx. 10 sec. after applying the operating voltage	
Electrical output		
	412x.12M 10.5 - 36 VDC	412x.13M 10.5 - 36 VDC
Switching condition with flow < switching point	energized, switched	currentless, not switched
LED	off	off
Switching condition with flow > switching point	currentless, not switched	energized, switched
LED	green	green
Cooling version – Temperature data		
Type	412x.1xMK 10.5 - 36 VDC	
Medium temperature in relation to ambient temperature	Medium temperature max.	Ambient temperature max.
	130 °C	30 °C
	120 °C	40 °C
	110 °C	50 °C
	100 °C	60 °C
	90 °C	70 °C
	Medium temperature min.	Ambient temperature min.
	-20 °C	-20 °C
-30 °C	-10 °C	

*1 related to water

*2 related to insulating oil type "Shell Diala S4 ZX-I"

Flow switch for liquid media



flow-captor 412x.1xM 10.5 - 36 VDC

Connection diagram:

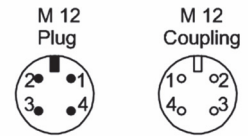
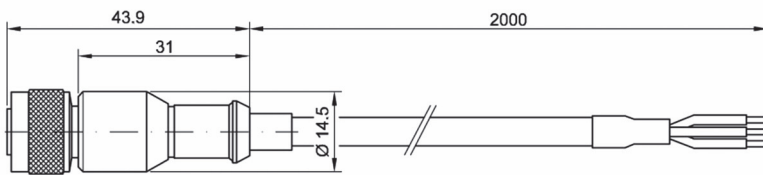
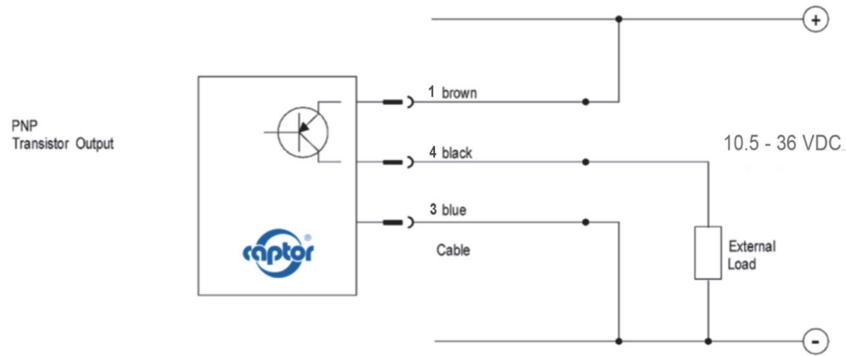

Front view onto the pins and sockets

M 12
Coupling

Cable
2 m
3 x 0.34 mm²

Dimensions in mm :

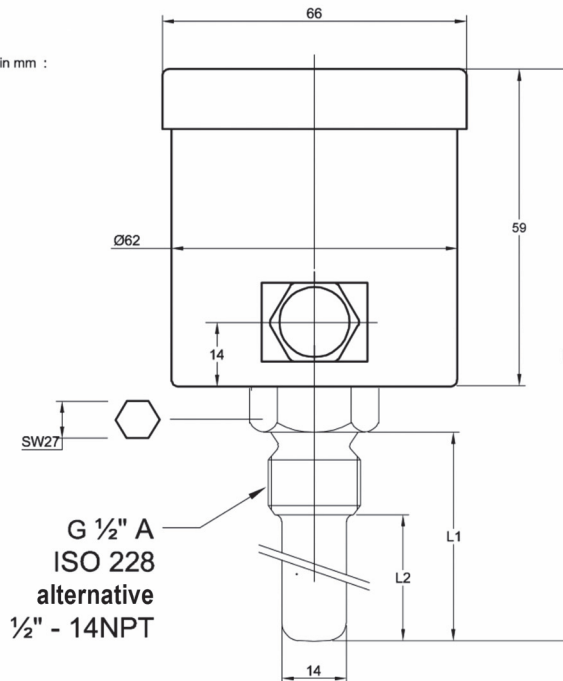

Type	L	L1	L2
Standard	109	30	12,5
S110/45	124	45	27,5
S110/67	146	67	49,5
S110/90	169	90	73,0

weber

Sensors GmbH Strohdeich 32
Sensors Ltd. 66 Eastbourne Road, Southport
Sensors LLC. 4462 Bretton Court, Building 1, Suite 7

DE-25377 Kollmar, Germany Tel.: +49 (0)4128 - 591 · Fax: - 593
Merseyside PR8 4DU, UK Tel.: +44 (1704) - 551684 · Fax: - 551297
Acworth, Georgia 30101, USA Tel.: +1 (770) 592 - 6630 · Fax: - 592 6640

www.captor.de
info@captor.de
sales@captor.co.uk
sales@captor.com